

Profibus DP

Series

Bus interface



**EUROTHERM
DRIVES**

**PRODUCT
MANUAL**



Further descriptions, that relate to this document

UL: 07-01-05-06



635 – Product manual

UL: 07-02-08-03



637 – Product manual

UL: 07-02-09-01



637+ – Product manual

UL: 10-06-03



Serial transfer protocol
EASY-serial - Product Description

© **EUROTHERM** Drives Limited.

All rights reserved. No portion of this description may be produced or processed in any form without the consent of the company.

Changes are subject to change without notice.

EUROTHERM has registered in part trademark protection and legal protection of designs.
The handing over of the descriptions may not be construed as the transfer of any rights.

Made in Germany, 2001

CONTENTS

Page

The most important thing first	5
1 Appendix for user manual Digital drive 635/637/637+ for the bus system Profibus DP	6
2 Basic features of the Profibus DP	6
2.1 Device data base	6
2.2 Ident number	6
2.3 Communication	6
3 Digital drive 635/637/637+ with Profibus DP	7
3.1 Data length	7
3.2 Bus watching	7
3.3 Station address	7
3.4 Schematic sketch	7
3.5 Selection of the correct baud rate	8
3.6 Bus termination	9
3.7 Fieldbus diagnosis via the EASYRIDER® shell	10
4 Definitions of the data field	11
4.1 Numbers representation in the serial commands	11
4.1.1 2 byte hexadecimal values (WORD)	11
4.1.2 4 byte hexadecimal values (LWORD)	11
4.2 Parameter scaling	11
4.3 Contents of the control word byte 0	12
4.3.1. Inhalte des Steuerwortes Byte 1 Contents of the control word byte 1	12
4.4 Edge change of the control word	13
4.4.1. Move commands without edge change	13
5 Data frames	14
5.1 Host login / logout (1/2)	14
5.2 Control word "start absolut" (3) and "start incremental" (4)	14
5.3 Control word "start reference run" ¹⁾ (5)	14
5.4 Control word "stop" (6)	15
5.5 Control word "stop with braking ramp" (7)	15
5.6 Control word "preset counter" (8)	15
5.7 Control word "set BIAS processing pointer" (9)	16
5.8 Control word "move +" (10) and "move -" (11)	16
5.9 Control word "move synchron on" (12)	16
5.10 Control word "synchron setting" (13)	17



CONTENTS

	Page
5.11 Control word "eyemark command 1" (14)	17
5.12 Control word "eyemark command 2" (15)	17
5.13 Control word "virtual axis" (16)	18
5.14 Control word "read data block" (17)	18
5.14.1 Input data	18
5.15 Control word "write data block" (18)	19
5.16 Control word reserved (19)	19
5.17 Control words Digital drive 635/637/637+: "disable/ enable" (20/21) "RESET" (22) "save data" (23)	19
5.18 Control word "operating mode speed loop" (24)	20
5.19 Control word "write/read variable / flags" (25)	21
5.20 Input buffer (Digital drive 635/637/637+ → master)	23
5.21 Data contents of the input buffers	24
6 Pin assignment bus interface Profibus DP	26
7 Example for operating the Digital drive 635/637/637 + via the Profibus DPfield bus system	27
7.1 Positioning via Profibus DP	27
7.2 Example for control by Siemens S7	30
7.2.1 Read Data	30
7.2.2 Write Data	31
7.2.3 Watch and control variables	31
8 Table of the block numbers for 635 /637	32
9 Standard reference modes overview	38
9.1 Reference run and modes	38
9.2 Reference run to the resolver zero position	39
9.3 Reference run to the reference sensor	40
9.4 Reference run to the reference sensor and the resolver zero position	41
9.5 Reference run with automatic selection of direction	41
9.6 Reference run with shifting of reference point	42
10 Appendix	43
11 Index	44
12 Modification Record	46

The most important thing first

We thank you for the trust that you have shown in our product.

The operating instructions presented hereserves as an overview of the technical data and features.

Please read the operating instructions before putting the product to use.

If you have any questions, please contact your nearest Eurotherm representative.

Improper application of the product in connection with dangerous voltage, can lead to injuries.

In addition, damage can also occur to motors or other products.

Therefore please observe strictly our safety precautions.

Topic: Safety precautions

We assume that as an expert, you are familiar with the relevant safety regulations, especially in accordance with VDE 0100, VDE 0113, VDE 0160, EN 50178, the accident prevention regulations of the employers liability insurance company and the DIN regulations and that you can use and apply them. Also the CE - regulations are to be observed and guaranteed.

Depending on the kind of application, additional norms e.g. UL, DIN are to be observed.

If our products are employed in connection with components from other manufacturers, their operating instructions are also to be strictly observed.



1 Appendix for user manual Digital drive 635/637/637+ for the bus system Profibus DP

A Profibus DP module (RP_PDP) can be integrated as an option into the Digital drive 635/637/637+. Consequently it is possible to network the Digital drive 635/637 as a slave in the Profibus DP bus system.

2 Basic features of the Profibus DP

The Profibus DP was developed for a fast data exchange. The bus access occurs between the masters (not Eurotherm drives) in **token passing mode** and to the peripheral devices in the **master slave mode**.

The bus cycle time will be calculated exactly only in a **mono master system** (only one master in the system).

A maximum of **126 participators** (master and slaves) can be connected on the bus system.

2.1 Device data base

Each Profibus DP device is characterized by typical features and the efficiency on the bus. These features are provided (according to the Profibus norm) to the user in the form of **device specification sheets** and a **device data base (GSD; ASCII-file)**.

The fixed file format facilitates the configuration of Profibus DP systems. This device master file (**GSD**) comes with the EASYRIDER[®] shell.

File name: ASB_1008.GSD

2.2 Ident number

Each participator must have an individual ident number. This make it easier to projekt the sytems and allows the unequivocal assignment of the connected participators.

The Ident number and the device data base will be controlled by the Profibus User Organisation (PNO).

The 635/637 has following ident number:

Ident number: **1008**

2.3 Communication

The maximum cable length depends on the transmission rate (see DIN 19245-3):

187,5 kBit/s:	up to 1000 m cable length
500 kBit/s:	up to 400 m cable length
1,5 MBit/s:	up to 200 m cable length
3 MBit/s:	up to 150 m cable length
6 MBit/s:	< 150 m cable length
12 MBit/s:	up to 100 m cable length

The Digital drive 635/637 supports baud rates up to 6 Mbit/s.

With baud rates > 1,5 Mbits/s **special connector plugs** are to be provided.

These contain the bus termination resistors and the corresponding inductivities, in order to reduce the line reflections.

Note:

When removing such plugs, there can be mismatches which can produce interference on the bus.

The communication occurs via the RS 485 standard. For the bus cable should be used a **twisted pair cable** with shield.

3 Digital drive 635/637/637+ with Profibus DP

3.1 Data length

At the Digital drive 635/637 there are configured **16 byte** for **input** and **output data**.

Byte for sign by configuration the master:

0xBF (hex) 191_d

3.2 Bus watching

The Digital drive 635/637 makes it possible, to detect a bus break and to execute a definition reaction.

For that, the **bus watching** must be activated by the master!

Follow reaction can activate after detected a bus break:

- **no reaction**
- **stop abrupt**
- **stop with braking ramp**
- **disable Digital drive 635/637**

The selection and the setting made by the EASYRIDER shell in the menu

→ **commissioning** → **fieldbus**.

3.3 Station address

The station address will be set with

Digital drive 635/637 by **DIP-switches** on the interface card or by the **EASYRIDER shell**.

- **valid address range: 2 - 125**

If the station address should be set by the EASYRIDER shell, the DIP-switches must set smaller than 2.

By the EASYRIDER shell you have to program the address in the menu → **commissioning** → **fieldbus**.

The changed data should be stored in the EEPROM with button */*.

It should be considered, that the setting of a station address **only during** the initialization of the Digital drive 635/637, so after when you switch on the power supply (24V), will be get in.

3.4 Schematic sketch

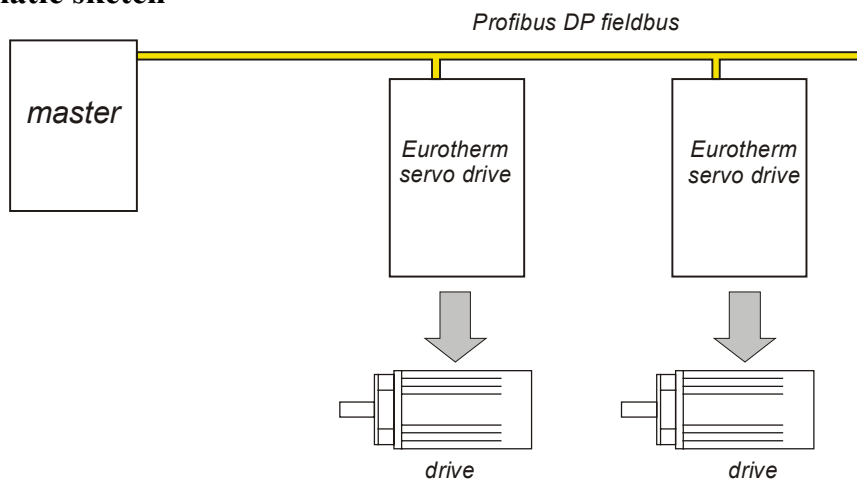



3.5 Selection of the correct baud rate

The baud rate should always be set high enough to fulfill the required system reaction time

The lower the baud rate is selected,

- the more insensitive the system is to interference from outside.
- the less difficult it will be to repress eventual interference.

The bus cycle time depends on the set baud rate.

It should not be less than the greatest telegram update time of a slave in the system.

This allows you to prevent telegrams arriving from the bus faster than they can be processed by the respective participant.

The update time for the 635/637 is 2 msec.

In a mono master system the system reaction time can be calculated in dependency on the selected baudrate as following:

The theoretically system reaction time =

$$[\text{token} + \text{GAP test} + \text{number of stations} * \text{offset} + \text{number of E/A-bytes} * 11 + T_{SM}] * t_{\text{Bit}}$$

Up to 1,5 MBit/s (all stations have inputs and outputs) and the lower limiting values according to DIN 19245-3 the cycle time can be calculated as follows:

$$\text{cycle time} = [70 + 403 + \text{number of stations} * 246 + \text{number of E/A-bytes} * 11 + 1] * t_{\text{Bit}}$$

Examples:

In the following, a few examples are shown of how the cycle time changes depending on the number of participants at the same baud rate.

Useful data: 16 bytes I/O per participant

		cycle time [ms]	
participator	Zyklus number of the transmit i/o bytes per cycle	500 kBit/s	1,5 MBit/s
2	64 Byte	3,3 ms	1,1 ms
4	128 Byte	5,7 ms	1,9 ms
5	160 Byte	6,9 ms	2,3 ms
10	320 Byte	12,9 ms	4,3 ms

Below an extract from the DIN 19245-3 to calculate the system reaction time:

Token :	$T_{ID1} + T_{Token}$	$= (37 + 33)^1 t_{\text{Bit}}$	$= 70 t_{\text{Bit}}$
GAP :	$T_{ID1} + T_{SD1} + T_{SL}$	$= (37 + 66 + 300)^1 t_{\text{Bit}}$	$= 403 t_{\text{Bit}}$
Offset :	$T_{ID1} + 2 * T_{SD2_R} + \min T_{SDR}$	$= (37 + 198 + 11)^1 t_{\text{Bit}}$	$= 246 t_{\text{Bit}}$
T_{SM} :			$= 1 t_{\text{Bit}}$

T_{Token} : time to send a token telegram

T_{SD1} : time to send a telegram with Start Delimiter SD1

T_{ID1} : Idle Time

T_{SDR} : Station-Delay-Time of the responder

T_{SL} : Slot-Time

T_{SM} : Safty Margin

¹ times for 1,5 MBit/s

3.6 Bus termination

For communication, a defined quiescent level must be ensured on the bus. Therefore termination resistors must be added to the **first** and **last** participant in the bus train.

At baud rates of up to 1,5 Mbits/s, the termination resistors integrated on the interface card of the Digital drive 635/637 can be used for one bus termination.

Both jumpers (9 and 10) are to be closed (**on**).

Bus plugs with integrated termination resistors can also be used.

With baud rates of > 1,5 Mbits/s special connecting plugs are to be used.
(see chapter 2.3, transmission technology)

a) 635 - plan view

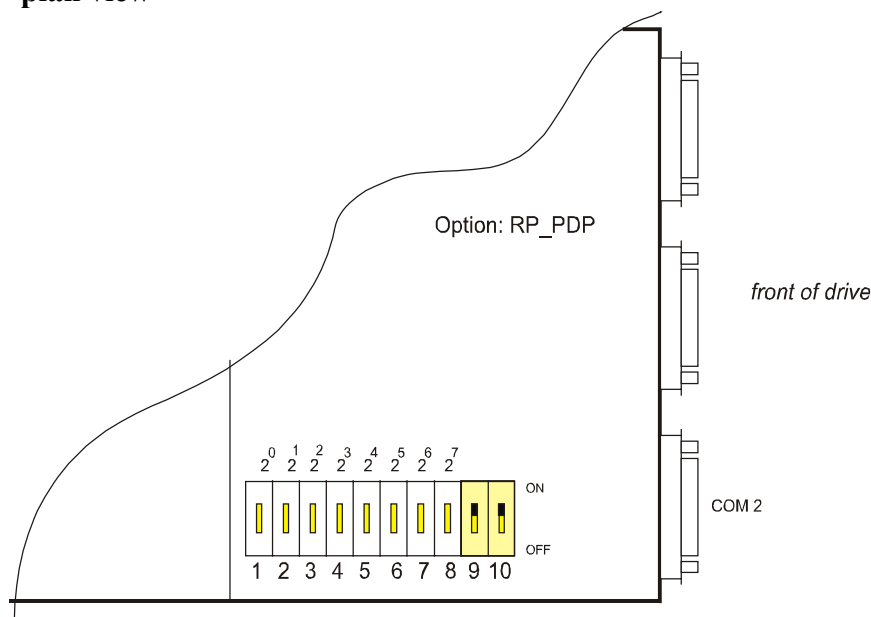

b) 637 - plan view

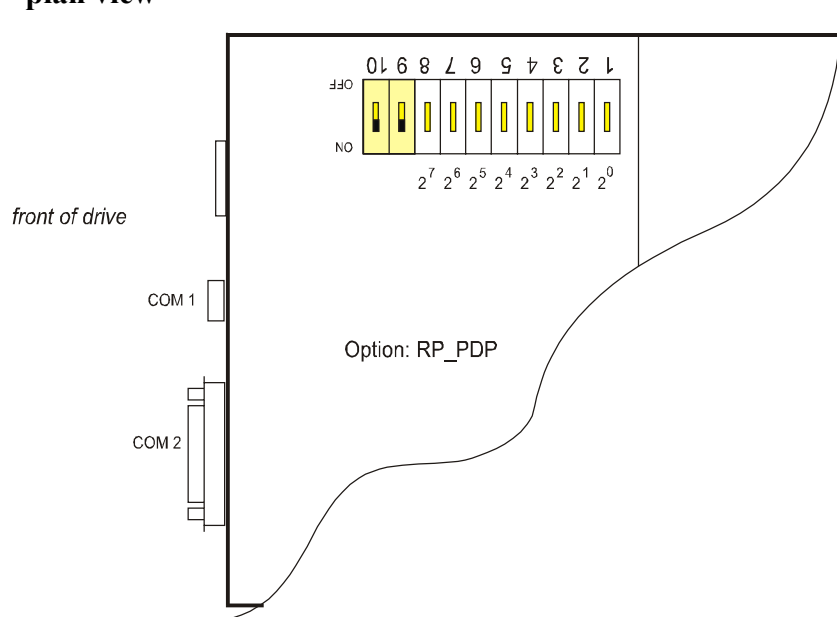

picture 3.1

DIP switches for: - station address (1 - 8)
- termination resistors (9, 10)



3.7 Fieldbus diagnosis via the EASYRIDER® shell

Additionally, the EASYRIDER shell also offers an online Profibus DP diagnosis display.

Menu: → **Diagnosis** → **Fieldbus**

This display offers the following possibilities for diagnosis:

- station address
- name of drive
- bus status: connection ok/ interrupted
This allows you to detect whether communication with the master exists.
- status:
Here the internal status of the Profibus ASICs is displayed.
Here the user gets important information about the internal state machine of the Profibus ASICs.
It can be very helpful for an initial commissioning.

0x49:	Master in STOP
0xA9:	Data exchange
0x05:	Connection interrupted

All other status displays indicate incorrect parameterization of the drive with the master.

- display of the baud rate
- firmware version of the Profibus DP interface
- display of the data contents of each received telegram.

4 Definitions of the data field

Definition of the data field in the Profibus DP fieldbus system for the Digital drive 635/637:

Output data (master → Digital drive 635/637):

16 byte data unit

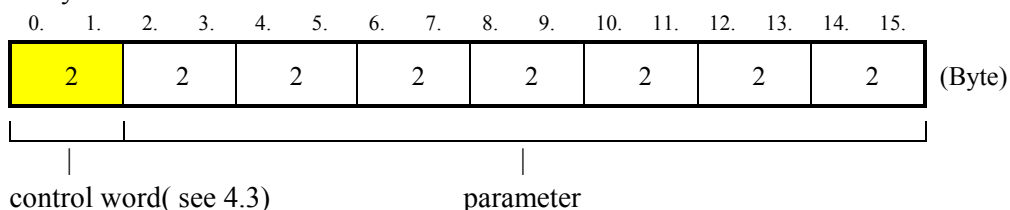

4.1 Numbers representation in the serial commands

4.1.1 2 byte hexadecimal values (WORD)

Number range $\pm 2^{15}$ (signed integer)

Example: The hexadecimal value 0123h

represents itself as follows:

01 = High-Byte (Byte 1)

23 = Low-Byte (Byte 2)

Precedence within the serial command:

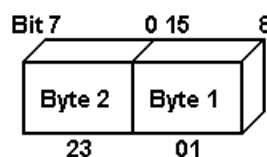

4.1.2 4 byte hexadecimal values (LWORD)

Number range $\pm 2^{31}$ (signed long)

Example: The hexadecimal value 01234567h represents itself as follows:

01 = High-Byte (Byte 1)

23 = Low-Byte (Byte 2)

45 = High-Byte (Byte 3)

67 = Low-Byte (Byte 4)

Precedence within the serial command:

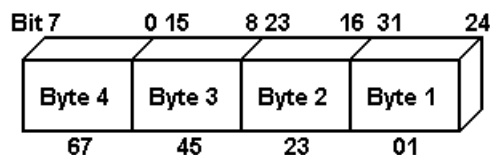

4.2 Parameter scaling

parameter	scaling
speed	value = v [rpm]
acceleration, deceleration:	value = a [rpm/s] / 5



4.3 Contents of the control word byte 0

command-
number

HOST-login necessary
activated drive necessary
Edge change necessary

dec	hex	command description				notes
0	00	read status				
1	01	Host login				attention! 2. interface login
2	02	Host logout	yes			
3	03	start absolute position	yes	yes	yes	
4	04	start incremental position	yes	yes	yes	
5	05	start reference run	yes	yes	yes	reference mode see chapter 9
6	06	stop		yes	yes	
7	07	stop (with braking ramp)		yes	yes	
8	08	preset counter	yes	yes	yes	
9	09	set BIAS-processing pointer	yes	yes	yes	only in operating-mode 5 with BIAS
10	0A	move +	yes	yes	yes	
11	0B	move -	yes	yes	yes	
12	0C	move synchron	yes	yes	yes	
13	0D	synchron adjustment	yes	yes		
14	0E	eyemark control 1	yes	yes		
15	0F	eyemark control 2	yes	yes		
16	10	virtual axis	yes	yes	yes	
17	11	data-bloc read				status-response see command
18	12	data-bloc write	yes	*)	yes	*) and status-response see command
19	13	not used				
20	14	deactivate Digital drive		yes		
21	15	activate Digital drive		no		
22	16	reset Digital drive	yes	no	yes	
23	17	store data in drive	yes	no	yes	
24	18	operating mode speed (serial)	yes			
25	19	read/ write variable/ flag			*)	*) edge and status-response see command

4.3.1. Inhalte des Steuerwortes Byte 1 Contents of the control word byte 1

dec	hex	command description
0	00	read status with realposition 1
1	01	read status with realposition 2

The answer(Inputbuffer) is described in chapter 5.20

4.4 Edge change of the control word

In installations the cycle times of the PLC and the respective bus system are often different and also not synchronous.

In this case the following points must be observed:

With normal program processing the PLC new telegrams to the bus master at a certain time. If the bus cycle time is now shorter than the PLC cycle time the telegrams will be sent several times according to the bus cycle time. New telegrams are usually transferred from the PLC again once after a further PLC cycle is ended.

Without a slope evaluation of the control words This fact would result in the commands being executed several times.

This is, however, undesirable with some commands.

With the command "start incremental" this would result in the specified position being added to setpoint position with every telegram received.

With telegrams with slope evaluation identical control words in sequence are only accepted once. For an intentional repetition of a control word another control word must be sent in between. For this the control word "0", actually not a command, can be used.

4.4.1. Move commands without edge change

As of firmware version 5.12 you have the possibility to send the following commands without edge change.

dec	hex	command description				notes
67	43	start absolute position	yes	yes	no	parameter like command 03
70	46	stop		yes	no	parameter like command 06
71	47	stop (with braking ramp)		yes	no	parameter like command 07
74	4A	move +	yes	yes	no	parameter like command 0A
75	4B	move -	yes	yes	no	parameter like command 0B
76	4C	move synchron	yes	yes	no	parameter like command 0C

command-number

HOST-login necessary

activated drive necessary

Edge change necessary



5 Data frames

5.1 Host login / logout (1/2)

The most data frames are accepted by the Digital drive only after a host registration.
 The host registration must only be sent uniquely to connecting the control voltage (24V).
 For Host login / logout only the control word from the Digital drive 635/637 will be evaluated. The 2nd to 15th bytes can contain any data.
 Only one interface will have a login (COM1 or COM2).

☞ Send a telegram (output data) with 01h 'Host login' in the control word to the 635/637.

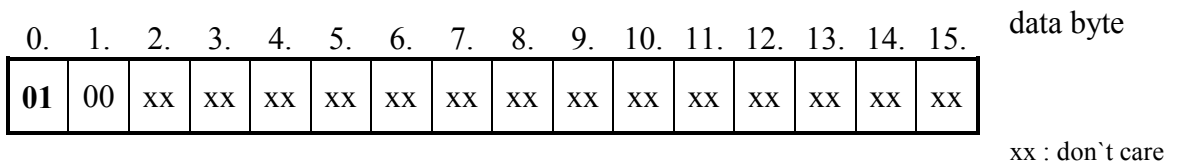

5.2 Control word "start absolut" (3) and "start incremental" (4)

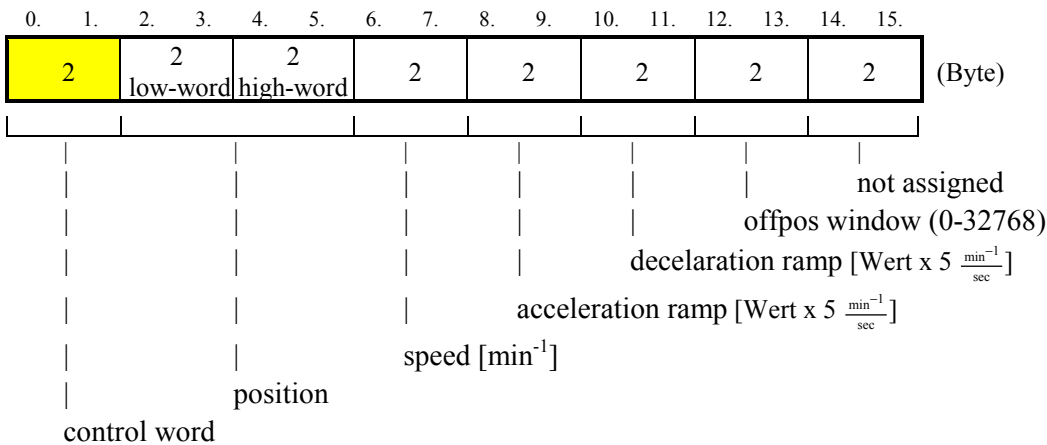

5.3 Control word "start reference run" ¹⁾ (5)

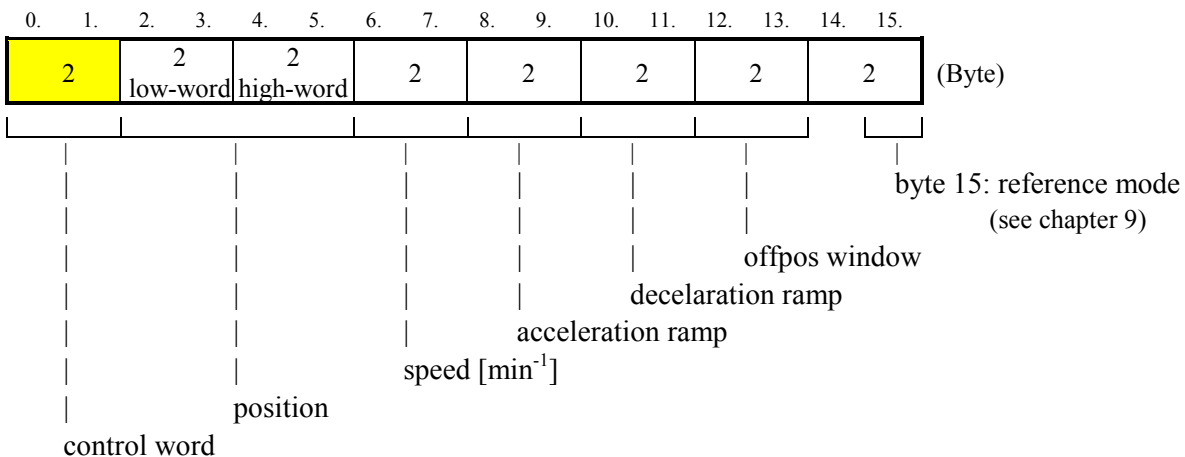

1) The reference run is only started, if the Bit "position reached" is set (= 1).
 (See also chapter -Data contents of the input buffers-)

Data frames

5.4 Control word "stop" (6)

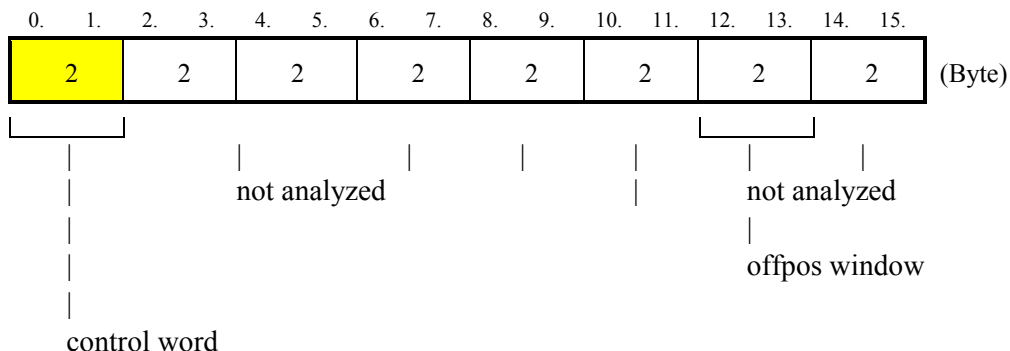

5.5 Control word "stop with braking ramp" (7)

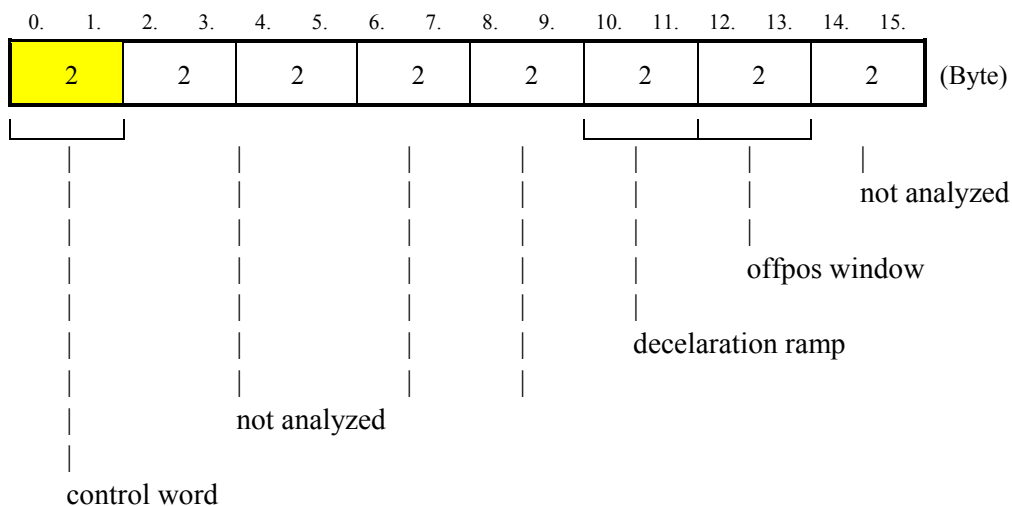

5.6 Control word "preset counter" (8)

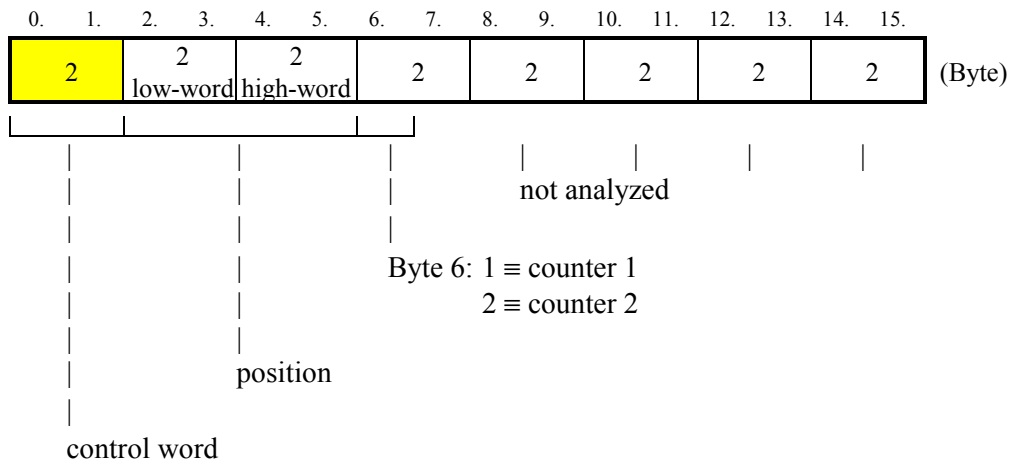



Data frames

5.7 Control word "set BIAS processing pointer" (9)

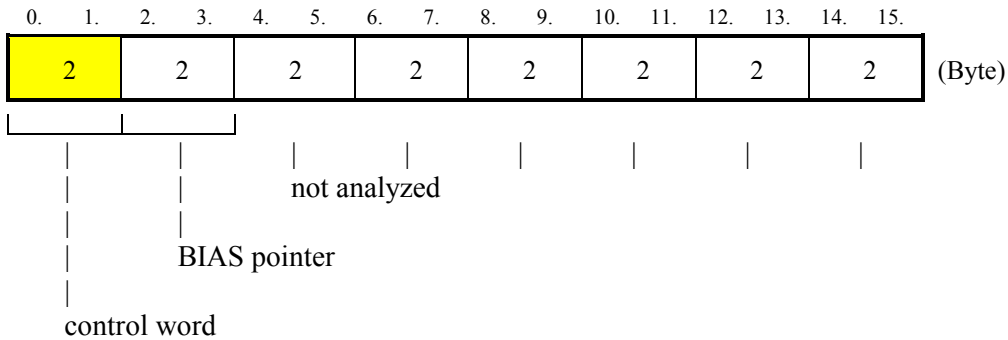

5.8 Control word "move +" (10) and "move -" (11)

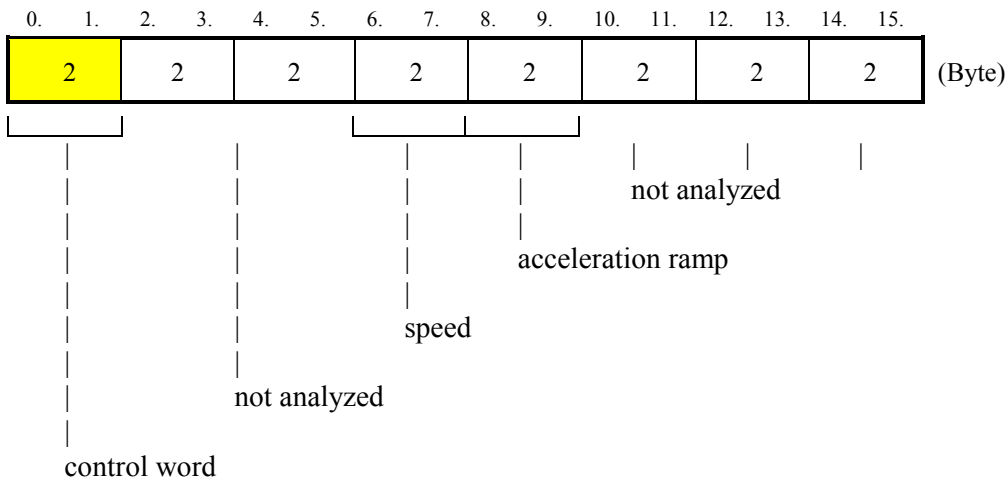

5.9 Control word "move synchron on" (12)

Starts the position synchronous positioning of the axis according to an external master encoder.

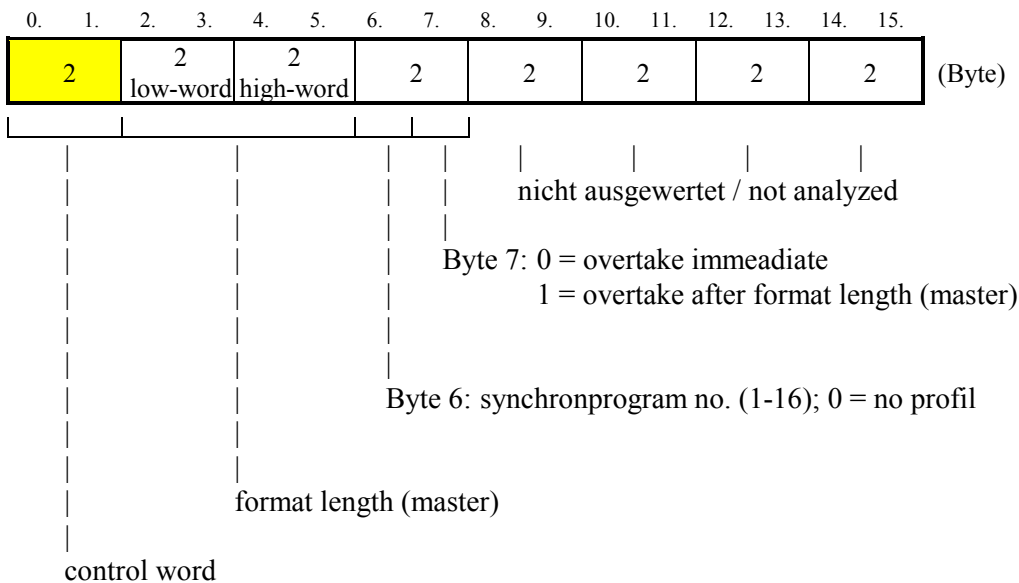

Data frames

5.10 Control word "synchron setting" (13)

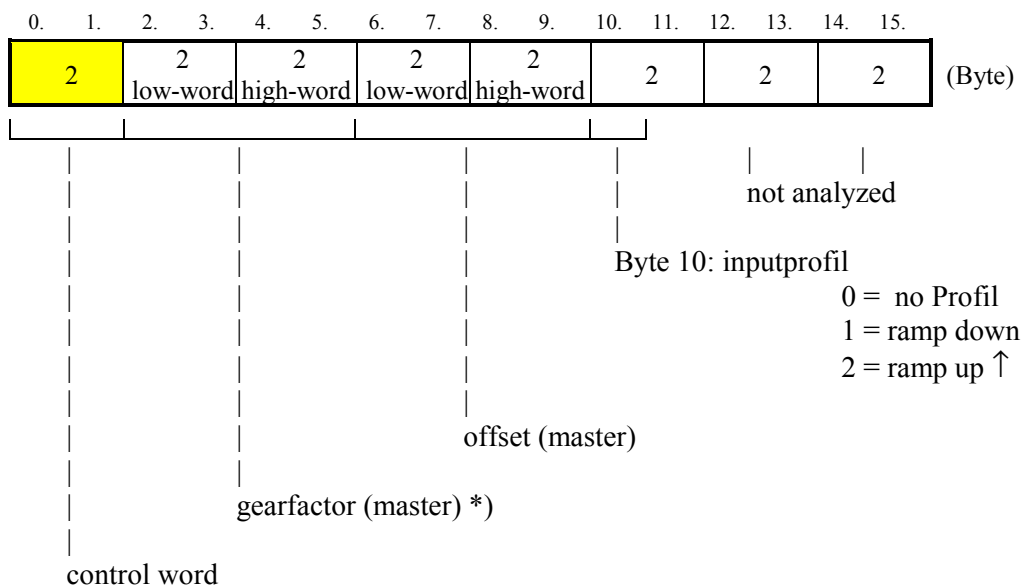

*)permitted variable content: $\pm 1 \dots 32767$. The content of the variable is interpreted as gear factor * 256.

5.11 Control word "eyemark command 1" (14)

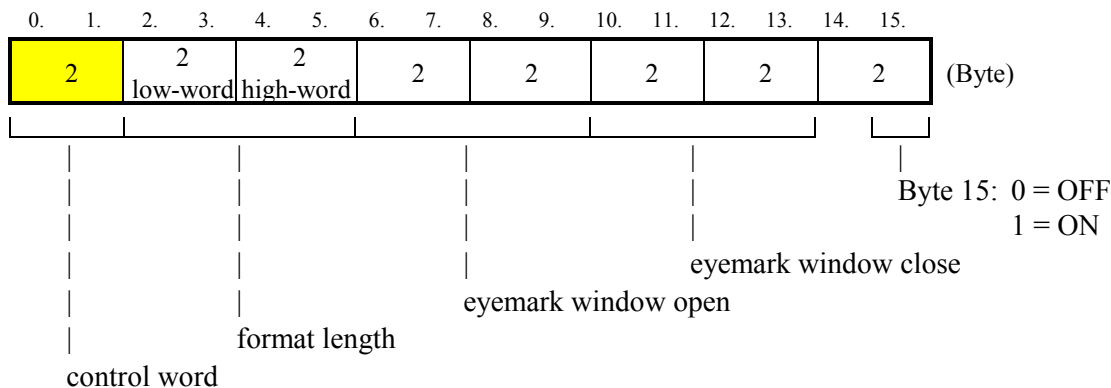

5.12 Control word "eyemark command 2" (15)

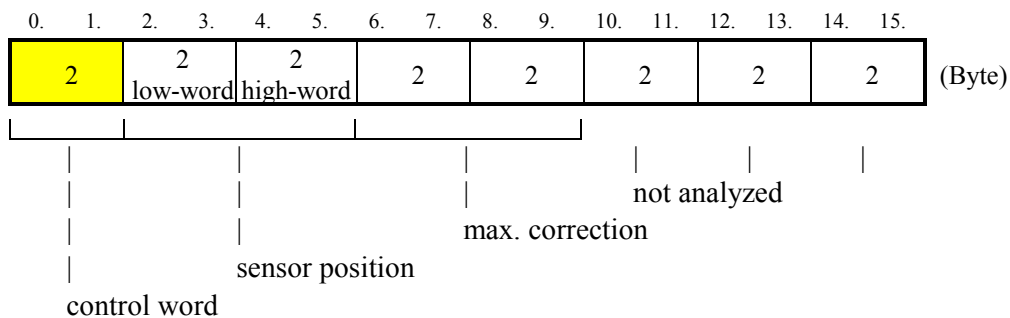



Data frames

5.13 Control word "virtual axis" (16)

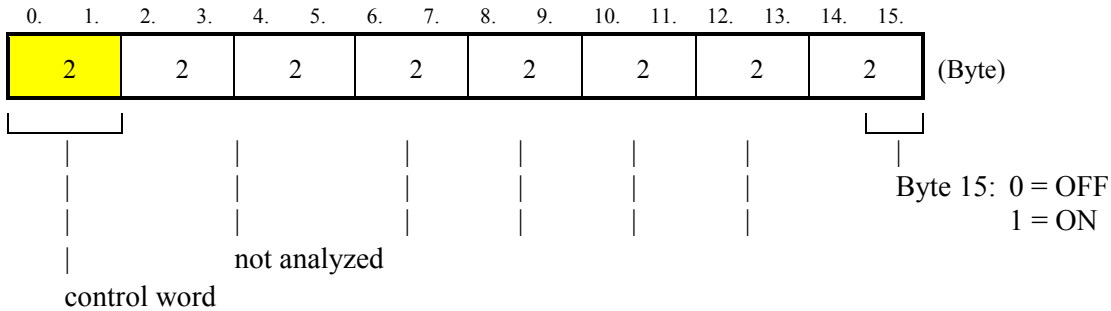

5.14 Control word "read data block" (17)

With 'read data block' the parameters of the requested data block and the following data block in the input data are returned. Only **even** data block numbers are accepted.

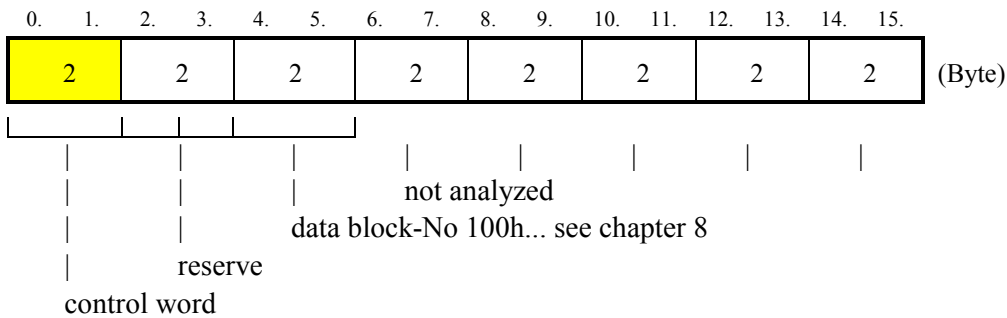

5.14.1 Input data

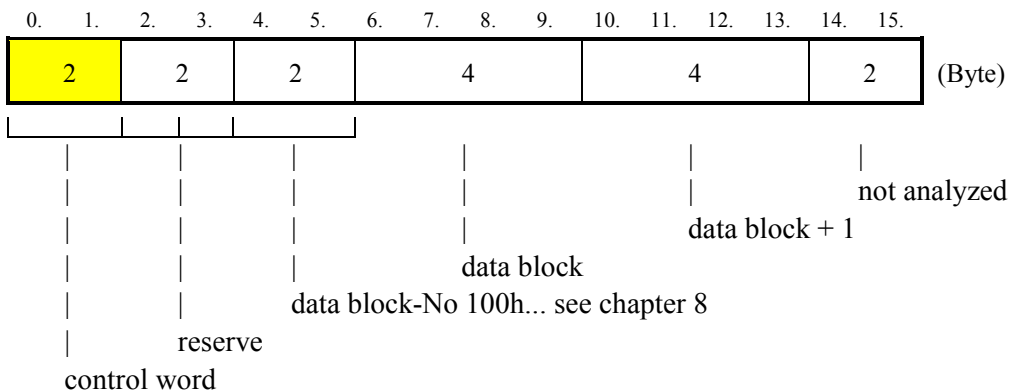

If an invalid block number is requested, the data contents of the input data of bytes 2 - 15 is **FF_h**

Data frames

5.15 Control word "write data block" (18)

Changing parameters on the Digital drive 635/637 is only possible if there has been a login through the master (Host login COM2).

If parameters are to be changed on the Digital drive 635/637, all 8 bytes of the parameter data must **always** be entered during "write data block" to the selected block number!

The table of block numbers is located in the chapter 8. In this connection, the marked areas can only be changed in the deactivated state of the regulator.

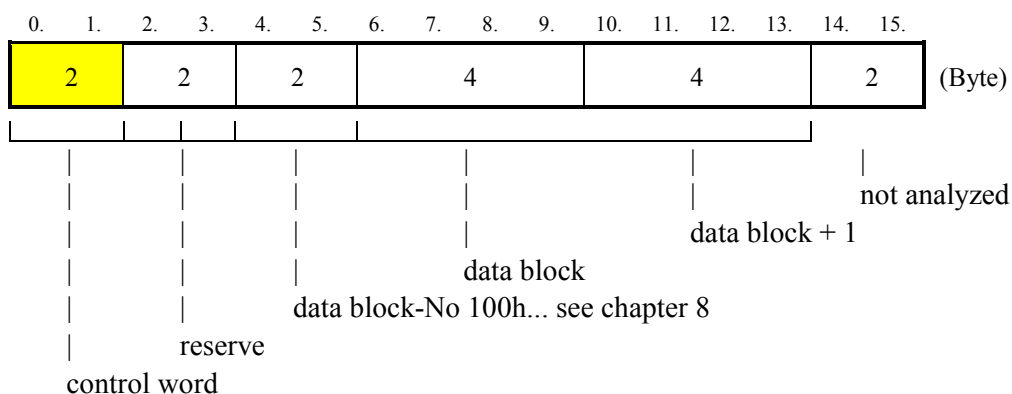

5.16 Control word reserved (19)

5.17 Control words Digital drive 635/637:

"disable/ enable" (20/21)

"RESET" (22)

"save data" (23)

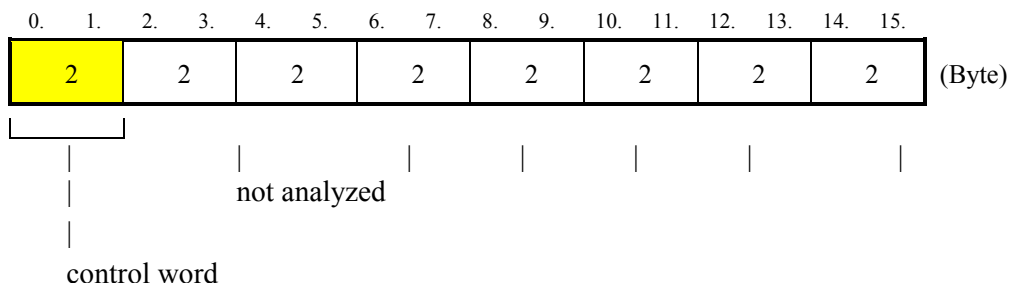



Data frames

5.18 Control word "operating mode speed loop" (24)

With this telegram you can send new speed values to the digital drive.

With byte 15 you can switch between rated value via the Profibus DP and analog rated value.

Caution:

If the the speed loop is switched off via the Profibus DP (byte 15 = 0) an analog value possibly applied to connector X10 pin 18 and 5 can be used.

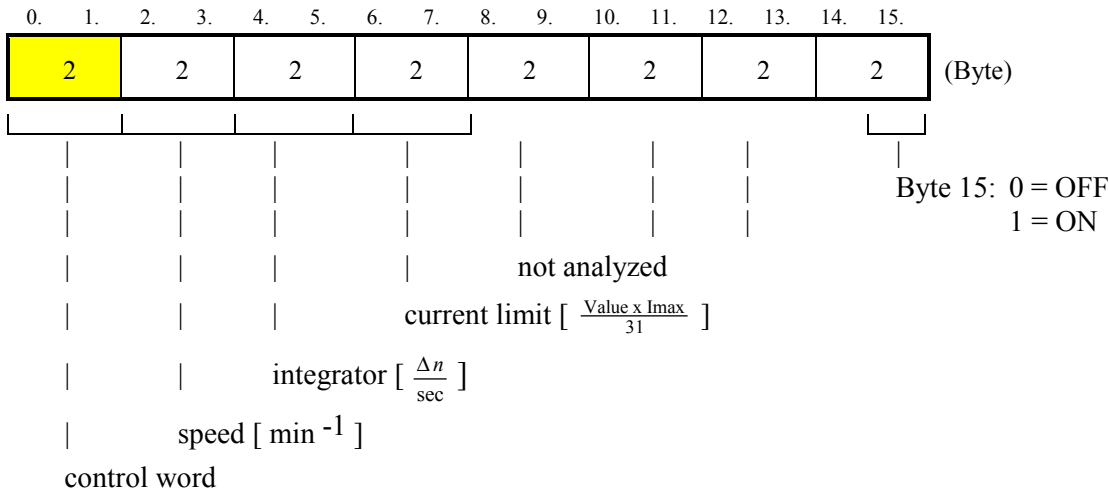

A negative speed is created through the 2 complement.

e.g.

$$+ 2000 \equiv 0x7D0$$

$$- 2000 \equiv 0xF82F$$

In order to use this function the operating mode speed control must selected in the digital drive.

This can be done either with the help of EASYRIDER or with the telegram,

"write data block".

The operating mode is preselected for the digital drive in block number 0x101.

Data frames

5.19 Control word "write/read variable / flags" (25)

in byte 2 of the outputbuffer the mode of the command is explained . In byte 3 the startadress of the variable or flag is defined.

- byte 2 = 0 write one variable
- byte 2 = 1 write one flag
- byte 2 = 2 write 3 ariables
- byte 2 = 3 write 4 flags
- byte 2 = 4 read 2 variables + realpos1
- byte 2 = 5 read 8 flags
- byte 2 = 6 write 3 var., read 3 var.

Notice:

After a write command (byte 2: 0 - 3) the Input buffer explained in chapter 5.21 will be received. This commands are only accepted with an edge change.

write:

Byte 2: **0**: write variable

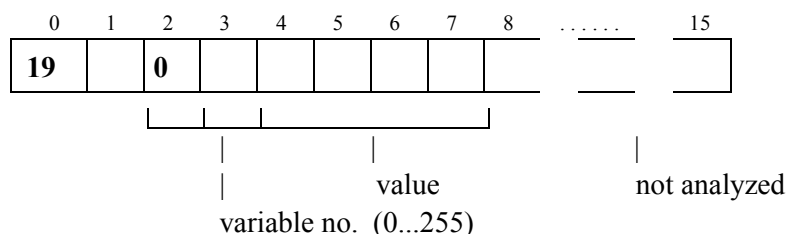

Byte 2: **1**: write flag

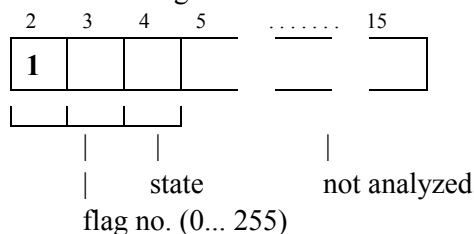

Byte 2: **2**: write 3 variables successive

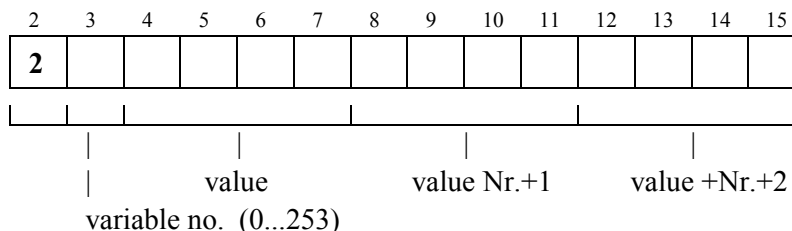

Byte 2: **3**: write 4 flages successive

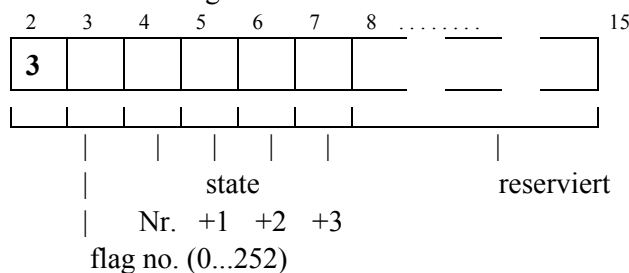



Data frames

Control word "write/read variable / flags" (25)

read:

request:

Byte 2: 4 : read 2 variables successive + actual position 1

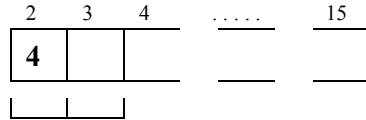

not analyzed
variable no. (0...254)

Input buffer:

Byte 2: 4 : read 2 variables successive + actual position 1

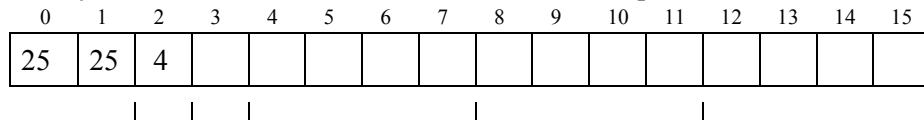

value Nr.
value Nr.+1
actual position 1
variable no. (0...254)

Control word "write/read variable / flags"(25)

request:

Byte 2: 5 : read 8 flages successive

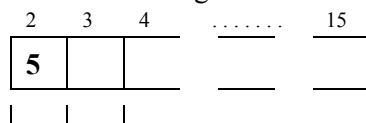

not analyzed
flage no. (0...248)

Input buffer:

Byte 2: 5 : read 8 flages successive

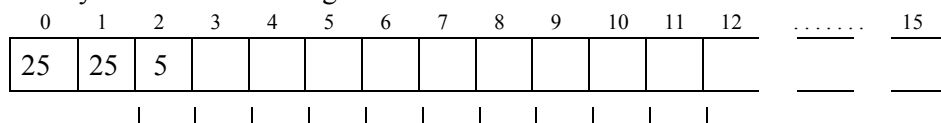

state
Nr. +1 +2 +3 +4 +5 +6 +7
flage no. (0...248)

Data frames

Control word "write/read variable / flags" (25)

request:

Byte 2: **6** : write 3 variables successive

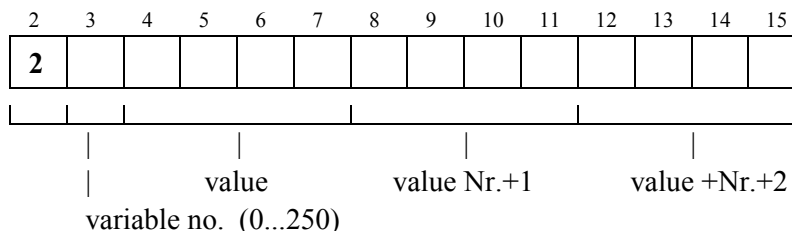

Input buffer:

Byte 2: **6** : read 3 variables successive

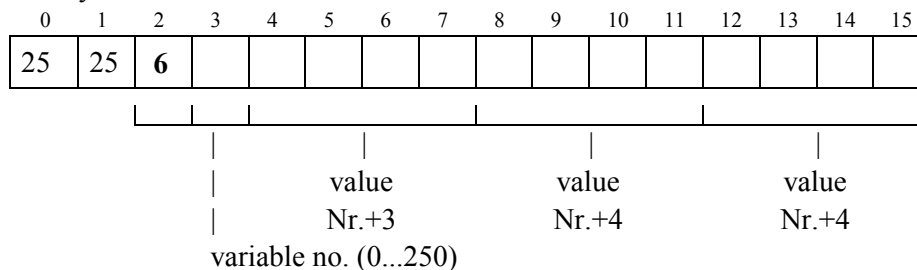

5.20 Input buffer (Digital drive 635/637 → master)

The data contents of the input puffer are engaged as a default with the necessary regulator information.

With byte 1 of the control word can be determined, whether in byte 2 - 5 of the status word the actual position 1 (byte 1=0) or the actual position 2 (byte 1=1) should be send return.

With the commands "read data block" (5.14) and "variable /flags" (5.19) is the returned status dependent on the respective command.

As of firmwareversion 5.12 you have the possibility to send the following commands without edge change. Sent control word 1:1 is then returned in bytes 0 and 1 in the status word.

16 Byte data unit

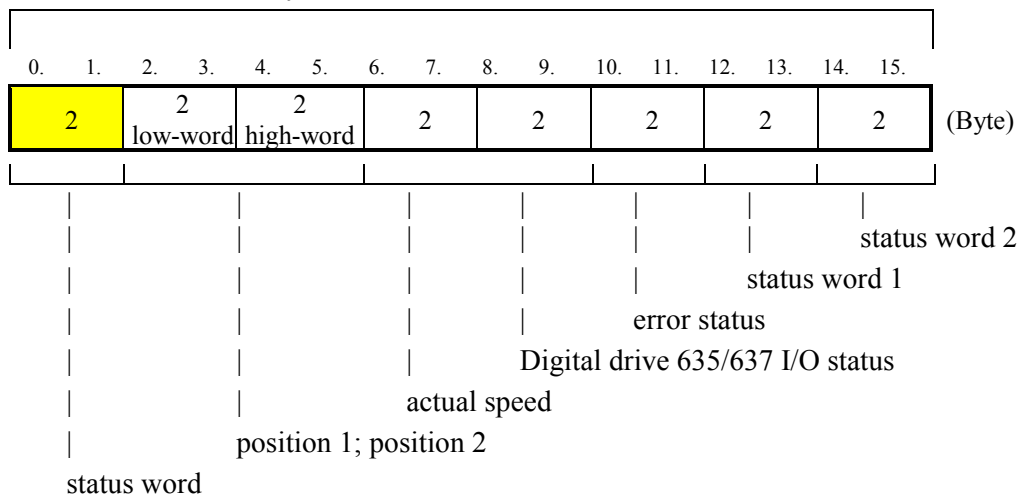



Data frames

5.21 Data contents of the input buffers

byte 0:

- a.) commandnumber ≤ 25
copy of the control word byte 0
(the last command will be stored if > 0)
- b.) commandnumber ≥ 64 (40 hex)
copie of the control word byte 0

byte 1:

- a.) commandnumber ≤ 25
copy of the control word byte 0
(for one data cycle, then 0)
- b.) commandnumber ≥ 64 (40 hex)
copie of the control word byte 1

byte 2-5:

actual position 1 / 2
(see "contents of the control word" byte 1)

byte 6+7:

actual speed in rpm

byte 8: Input status

7	6	5	4	3	2	1	0
X10.4	X10.11	X10.25	X10.2	X10.14	X10.15	X10.24	X10.22

byte 9: Output status

7	6	5	4	3 ¹	2 ¹	1	0
target position reached ²	position control basic ²	Limit switch reached ²	Output X10.12	Output X10.13	Output X10.20	Output X10.23	Output X10.8

byte 10: Error status 1

7	6	5	4	3	2	1	0
I ² t-motor	Overvoltage	Temperature of the output stage too high	Motor temperature too high	Resolver error	internal used	active before ready	Overcurrent (Software)

¹ inverted logic

² as of firmware 5.12

Data frames

Data contents of the input buffers

byte 11: Error status 2

7	6	5	4	3	2	1	0
Watchdog-Reset	Internal stop	Overcurrent (Hardware)	not used	not used	EEPROM-check total	Ballast power exceeded	I ² t-regulator

byte 12: Status word 1 byte1

7	6	5	4	3	2	1	0
Setpoint within setpoint zero window	Warning output stage temperature	Warning I ² t-regulator	Warning motor temperature	Warning I ² t-motor	Ballast active	Undervoltage	Output stage passive

byte 13: Status word 1 byte2

7	6	5	4	3	2	1	0
Limit switch reached	Warning ³³	Speed regulator without I-gain	internal used	EEPROM-storage runs	Warning ballast power	N/I switchover	internal used

byte 14: Status word 2 byte 1

7	6	5	4	3	2	1	0
Position reached	internal used	internal used	COM2 disabled drive	target position reached	internal used	COM2 host login	COM2 active (RS232/422)

byte 15: Status word 2 byte 2

7	6	5	4	3	2	1	0
Trailing distance ok dynamically	Trailing distance ok	referenced	COM1 disabled drive	new format started	registration error	COM1 hostlogin	COM1 active

³ total warning, without T1



6 Pin assignment bus interface Profibus DP

Connection plug: **SUB D-9 female**

The Profibus DP interface is galvanically isolated which makes the physical transmission free of interference.

Provided module: **RP_PDP**

Pin	Designation	Description
3	B	Line B
4	RTS	Request to Send
5	GND	Ground
6	+5V	Potential +5V
8	A	Line A

The voltage provided on COM2 PIN 5 and PIN 6 (+5V) serves as a voltage supply of the external bus termination resistors (connecting plugs with internal termination resistors).

The signal RTS is required for the direction detection with fibre optic connections (LWL).

7 Example for operating the Digital drive 635/637 via the Profibus DPfield bus system

7.1 Positioning via Profibus DP

1. Step:

Host login via the Profibus DP bus
(once after power on, or always after host logout necessary)

- ☞ Send a telegramm (output data) with 01h 'Host login' in the control word to the 635/637.

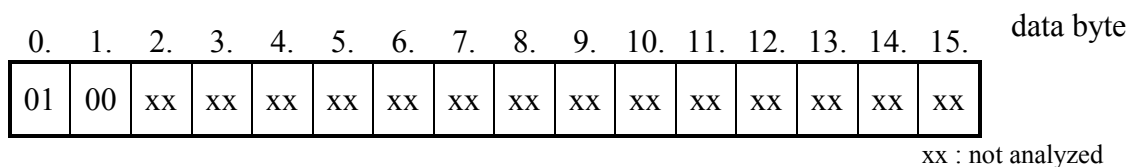

2. Step:

check host login

In the input data (master) in the data byte 14 the bit 1 'COM2 host login' will be set.

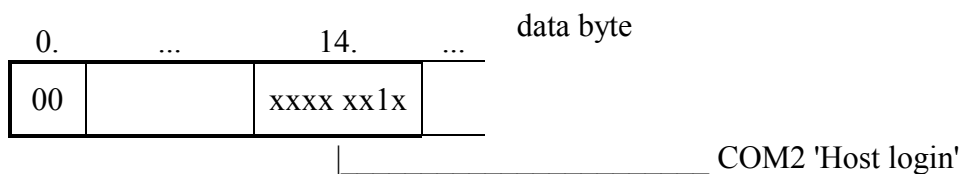



Example for operating the Digital drive 635/637 via the Profibus DPfield bus system

Positioning via Profibus DP

3. Step:

position with 'start absolut'

☞ Send a telegramm (output data) with the control word 'start absolut' and the parameters for position and speed to the Digital drive 635/637.

1. Example:

- Position 500.000 increments (500.000d ≡ 0007A120h)
- speed 2000 (≡ 7D0h) [1/rpm]
- acceleration 1000 (≡ 3E8) [value x 5 $\frac{\text{min}^{-1}}{\text{sec}}$]
- deceleration 1500 (≡ 5DC) [value x 5 $\frac{\text{min}^{-1}}{\text{sec}}$]
- offpos window 100 (≡ 64h)

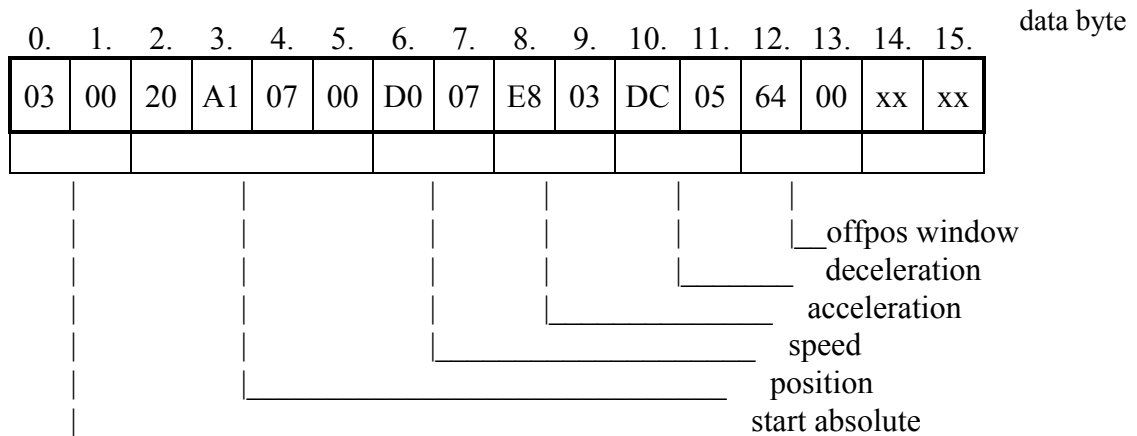

2. Example:

- Position 0 increments (00d ≡ 00h)
- speed 2000 (≡ 7D0h) [1/rpm]
- acceleration 1000 (≡ 3E8) [value x 5 $\frac{\text{min}^{-1}}{\text{sec}}$]
- deceleration 1500 (≡ 5DC) [value x 5 $\frac{\text{min}^{-1}}{\text{sec}}$]
- offpos window 100 (≡ 64h)

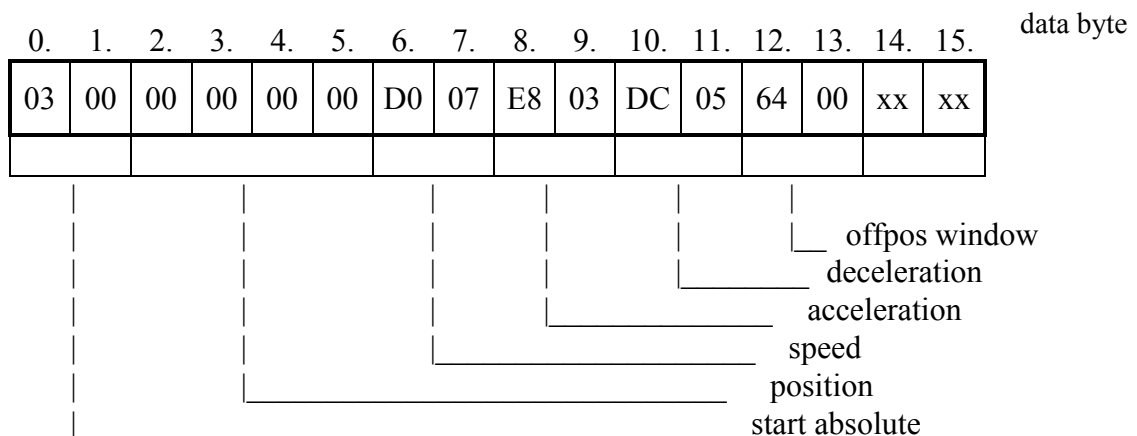

Example for operating the Digital drive 635/637 via the Profibus DPfield bus system

Positioning via Profibus DP

4. Step:

check 'position reached'

In the input data in the data byte 15 the bit 5 'position reached' can be checked, and / or the position value (byte 2 - 5) can be compared with the set value.

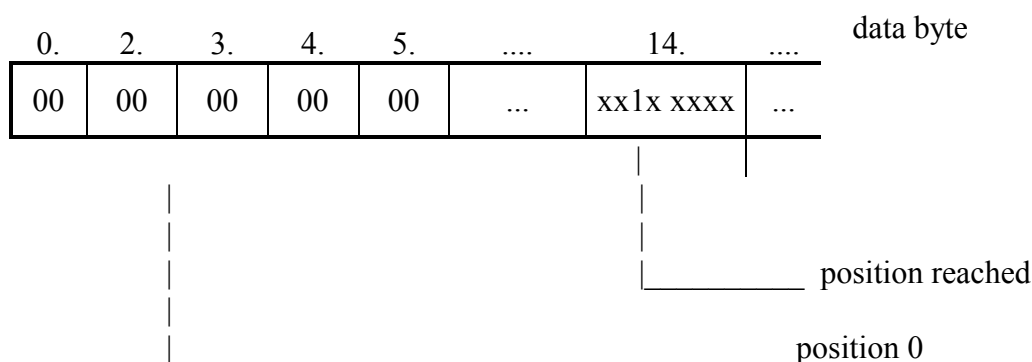

5. Step:

host logout via the Profibus DP bus

- ☞ Send a telegramm (output data) with 02h 'host logout' in the control word to the 635/637.

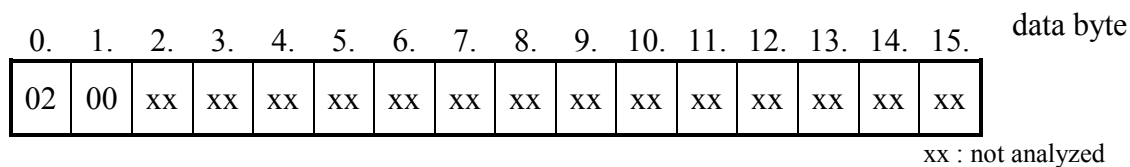



Example for operating the Digital drive 635/637 via the Profibus DPfield bus system

7.2 Example for control by Siemens S7

In order to address profibus participants with the the Siemens S7 controller with a consistent data length of more than 4 bytes, the following functional modules must be used:

SFC 14: read data consistent

SFC 15: write data consistent

With it assists the point of view is to be seen always from the master.

These functional modules must then be inserted in a the corresponding place in the program execution.

7.2.1 Read Data

With 'call SFC 14' the module is called up into the net. The corresponding specifications must be entered subsequently after the '='.

CALL SFC 14

LADDR := W#16#200

RET_VAL := MW100

RECORD := P#DB100. DBx 0.0 Byte 16

W#16#200 :

Gives the word address of the memory area for which a participant was configures.

e.g. Address 0x200 \equiv 500_d

MW100:

The functional module must be able to store pending messages in a flag word.

P#DB100. DBx 0.0 Byte 16:

Target area, in which the entry data are stored.

e.g in data module 100, as of byte 0 for 16 bytes.

Example for operating the Digital drive 635/637 via the Profibus DPfield bus system

Example for control by Siemens S7

7.2.2 Write Data

With 'Call SFC 15' the module is called up into the network. The corresponding specifications must subsequently be entered by the user after the '='.

CALL SFC 15

LADDR := W#16#200

RECORD := P#DB100. DBx 20.0 Byte 16

RET_VAL := MW102

W#16#200 :

gives the word address of the memory area for which a participant was configured.

e.g. address 0x200 \equiv 512_d.

P#DB100. DBx 20.0 Byte 16:

Target area in which the output data for the slave are stored.

e.g. in data module 100, as of byte 20 for

16 bytes.

MW102:

The functional module must be able to store pending messages in a flag word.

7.2.3 Watch and control variables

An initial data exchange can be made with the online function in the Siemens programming software in the corresponding module with:

LOAD → ‚Observing and controlling variables‘

for reading (example):

DB100.DBW 0

2

4

...

for writing (example):

DB100.DBW 20

22

24

...



8 Table of the block numbers for 635 /637

Note:

The marked block numbers may only be changed in the deactivated state of the regulator.

block-no.	Meaning	Value range	Byte X in telegram frame
100h	Axis identification with networking	1 - 255	Byte 6
	reserved		Byte 7
	Function identification for ISP function	0 - 3 0 = Output 1 = Input 2 = Stepper motor pulse/direction 3 = Stepper motor pos./negative	Byte8
	Output increments	0 - 3 0 = 1024 1 = 512 2 = 256 3 = 128	Byte 9
101h	635 / 637 operating modes	0 - 5 0 = torque-speed control 1 = speed control 2 = torque control 3 = position-speed control 4 = position control 5 = position control + BIAS	Byte 10
	reserved		Byte 11
	reserved	0/1	Bit 0 in Byte 12
	reserved	"	Bit 1 in Byte 12
	1 = 14 BIT Resolver resolution (16384 increments / rpm)	"	Bit 2 in Byte 12
	1 = Motor temperature sensor PTC	"	Bit 3 in Byte 12
	1 = current drop with warning active	"	Bit 4 in Byte 12
	1 = program switch locked	"	Bit 5 in Byte 12
	1 = analog input for external current limiting aktive	"	Bit 6 in Byte 12
	1 = internal ballast present and active	"	Bit 7 in Byte 12
	1 = slope monitoring of the active input	"	Bit 0 in Byte 13
	1 = monitoring control voltage	"	Bit 1 in Byte 13
	1 = position control on actual position 2	"	Bit 2 in Byte 13
	1 = MP2 for position output	"	Bit 3 in Byte 13
	1 = sinus ramps active	"	Bit 4 in Byte 13
	1 = direction of rotation positive	"	Bit 5 in Byte 13
	reserved	"	Bit 6 in Byte 13
	1 = counter direction actual position 2 positive	"	Bit 7 in Byte 13
102h	Active OK deceleration table level 0 - 4 in 200 ms steps	0 - 4	Byte 6
	position reached low time	0 - 255 ms	Byte 7
	Ucc overvoltage threshold	400 / 765 V	Byte 8,9
103h	UCC- low threshold	15 - 350 V	Byte 10,11
	UCC-ballast threshold	15 - 400 V	Byte 12,13
104h	ballast resistor in 1/10 Ω	10 - 999 ohm	Byte 6,7
	ballast power	10 - 999 watt	Byte 8,9

Table of the block numbers for 635 /637

continued

block-no.	Meaning	Value range	Byte X in telegram frame
105h	reserved		Byte 10,11
	reserved		Byte 12,13
106h	rated current motor		Byte 6,7
	number of pole pairs		Byte 8,9
107h	EMF/1000min-1		Byte 10,11
	Motor inductance (terminal inductance)		Byte 12,13
108h	Motor resistance (terminal resistance)		Byte 6,7,
	12T Monitoring time		Byte 8,9
109h	resistance value NTC T1		Byte 10,11
	resistance value NTC T2		Byte 12,13
10Ah	resistance value PTC		Byte 6,7
	byte 6 = ramp-filter, byte 7 = flag ramp-filter	0-32	Byte 8,9
10Bh	motor name ASCII 18 bytes		Byte 10,11
			Byte 12,13
10Ch			Byte 6,7
			Byte 8,9
10Dh			Byte 10,11
			Byte 12,13
10Eh			Byte 6,7
			Byte 8,9
10Fh			Byte 10,11
	reserved		Byte 12,13
110H	Maximum current limit - grade value (grade = $I_{max}/32$)	0-31	Byte 6,7
	P_gain - grade value for the current controller ²	0-31	Byte 8
	I_gain - grade value for the current controller ⁵	0-31	Byte 9
111h	P_gain - grade value for the speed controller ⁵	0-31	Byte 10
	I_gain - grade value for the speed controller ⁵	0-31	Byte 11
	P_gain position controller	1 - 32767	Byte 12,13
112h	I_gain position controller	1 - 32767	Byte 6,7
	V_gain position controller	256 - 1/256	Byte 8,9
113h	Default speed for position controller in rpm * 1,45	(0 - 12000) * 1,45	Byte 10,11
	Default braking ramp for position controller [value x $5 \frac{\text{min}^{-1}}{\text{sec}}$]	0 - 64000	Byte 12,13
114h	Default acceleration ramp for position controller [value x $5 \frac{\text{min}^{-1}}{\text{sec}}$]	0 - 64000	Byte 6,7
	Default position reached for position controller in increments	0 - 32767	Byte 8,9

² see appendix



Table of the block numbers for 635 /637

continued

block-no.	Meaning	Value range	Byte X in telegram frame
115h	Trailing window in increments	0 - 32767	Byte 10,11
	Trailing reaction	0 - 3 0 = without reaction 1 = stop abrupt 2 = stop 3 = deactivate regulator	Byte 12
	reserved		Byte 13
116h	window for 0 V setpoint	+/- 150 mV	Byte 6,7
	Setpoint integrator-steepness 10000 = off (without integrator)	<= 9999 in 5 min/s Steps	Byte 8,9
117h	Setpoint evaluation X10 5/18	+/-14000 rpm	Byte 10,11
	Setpoint evaluation with torque control in 1/100 A		Byte 12,13
118h	Setpoint value norming test point 1 speed	200 - 15000 rpm	Byte 6,7
	Setpoint value norming test point 2 current in 1/100 A	2 - +10% I _{max}	Byte 8,9
119h	Norming analog input external current limiting 1/100	0,1 - 20 V	Byte 10,11
	Speed 0 offset storage value +/-311 mV	+/-512	Byte 12,13
11Ah	Offset resolver position	always 0	Byte 6,7
	reserved		Byte 8,9
11Bh			
....	reserved		
136h			
800h - 8FFh	Reserved for EASYRIDER extra info		
900h - 9FFh	Initializing data for the 16 possible synchronous profiles		
A00h	Input definition input X 10.2 (function 0 - 3 see operating instructions)	0 - 3	Byte 6
	Input definition input X 10.4	0 - 3	Byte 7
	Input definition input X 10.11	0 - 3	Byte 8
	Input definition input X 10.14	0 - 3	Byte 9
A01h	Input definition input X 10.15	0 - 3	Byte 10
	Input definition input X 10.24	0 - 3	Byte 11
	Input definition input X10.25	0 - 3	Byte 12
	Output definition output X 10.12	0 - 2	Byte 13
A02h	Output definition output X 10.1	0 - 2	Byte 6
	Output definition output X 10.20	0 - 2	Byte 7
	Output definition output X 10.23	0 - 2	Byte 8
	reserved	x	Byte 9
A03h	reserved		Byte 10-13

Table of the block numbers for 635 /637

continued

block-no.	Meaning	Value range	Byte X in telegram frame	
	10 position sets a' 14 byte			
A04h	COMMAND	position set 0	0 - 255 (see EASYRIDER)	
	free		-	
	speed in rpm * 1,45		(0 - 12000) * 1,45	
A05h	acceleration ramp [value x 5 $\frac{\text{min}^{-1}}{\text{sec}}$]		0 - 32000	
	braking ramp [value x 5 $\frac{\text{min}^{-1}}{\text{sec}}$]		0 - 32000	
A06h	position reached window in increments		0 - 32767	
	setpoint position low word		32 Bit	
A07h	setpoint position high word		32 Bit	
↓	COMMAND		position set 1	0 - 255 (see EASYRIDER)
			"	Byte 12,13
....				
A26h	long SOLL_POS; high word	position set 9		
A027h	special funktion I_Conversion 4 Byte	float		
A028h	special funktion S_Conversion 4 Byte	float		
A029h	pulse_z2 4 Byte			
....				
A3F	reserve			
A40h - A7Fh	BIAS program info data			
A40h	BIAS_START_SET	0 - 1499		
	BIAS_STOP_MODE	0/1		
A41h	SPS_STOP_MODE	0 - 2		
	VIRTUAL_MODE	0		
A42h	Program name 64 Byte			
....			
A51h				
A52h	BIAS - program data Byte 1 - 4			
	BIAS - program data Byte 5 - 8			
A54h	BIAS - program data Byte 9 - 12			
A55h	BIAS -program version Byte 1 - 4			
A56h	BIAS -program version Byte 5 + 6; reserve 2 Byte			
A57h	reserved until A7Fh			
A80h - ABFh	BUS module data			
A80h	until A83h reserve			
A84h	SUCOnet_K BUS Axis-number	1 - 255	Byte 6	
	SUCOnet_K BUS Bus interruption	0 - 3 0 = without reaction 1 = stop abrupt 2 = stop 3 = deactivate regulator	Byte 7	
	SUCOnet_K BUS braking ramp [value x 5 $\frac{\text{min}^{-1}}{\text{sec}}$]	0 - 64000	Byte 8,9	



Table of the block numbers for 635 /637

continued













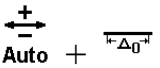

block-no.	Meaning	Value range	Byte X in telegram frame
A85h	until A87h reserve		
A88h	PROFIBUS axis-number	1 - 255	Byte 6
	PROFIBUS bus interruption	0 - 3 0 = without reaction 1 = stop abrupt 2 = stop 3 = deactivate regulator	Byte 7
	PROFIBUS braking ramp [value x $5 \frac{\text{min}^{-1}}{\text{sec}}$]	0 - 64000	Byte 8,9
A89h	until A8Bh reserved		
A8Ch	CAN-BUS Node number	1 - 255	Byte 6
	CAN-BUS Bus interruption	0 - 3 0 = without reaction 1 = stop abrupt 2 = stop 3 = deactivate regulator	Byte 7
	CAN-BUS braking ramp [value x $5 \frac{\text{min}^{-1}}{\text{sec}}$]	0 - 64000	Byte 8,9
A8Dh	CAN-BUS baud rate	0 - 6	Byte 10
	CAN-BUS bus-mode ASB , CAL	0/1	Byte 11
	CAN-BUS extended identifier j/n	0/1	Byte 12
	CAN-BUS send status automatically j/n	0/1	Byte 13
A8Eh	until A8Fh		
A90h	CAN_IID Message 0		
A91h	CAN_IID Message 1		
A92h	CAN_IID Message 2		
A93h	CAN_IID Message 3		
A94h	CAN_IID Message 4		
A95h	CAN_IID Message 5		
A96h	CAN_IID Message 6		
A97h	CAN_IID Message 7		
A98h	CAN_IID Message 8		
A99h	CAN_IID Message 9		
A9Ah	CAN_IID Message A		
A9Bh	CAN_IID Message B		
A9Ch	CAN_IID Message C		
A9Dh	CAN_IID Message D		
A9Eh	CAN_IID Message E		
A9Fh	CAN_IID Message F		

Table of the block numbers for 635 /637

continued

block-no.	Meaning	Value range	Byte X in telegram frame
AA0h	INTERBUS ASB profile = 0, profile 22 = 1	0/1	Byte 6
	INTERBUS bus interruption	0 - 3 0 = without reaction 1 = stop abrupt 2 = stop 3 = deactivate regulator	Byte 7
	INTERBUS braking ramp [value x $5 \frac{\text{min}^{-1}}{\text{sec}}$]	0 - 64000	Byte 8,9
AA1h	until ABFh		
AC0h-FFFh reserve			
1000h - 1FFFh	Synchronous profiles (according to EASYRIDER calculation)		
2000h - 2FFFh	BIAS program 0 - 1499 blocks (of 8 bytes)	see EASYRIDER help	
	set number 0 = adress 2C000H - 2C007h = BUS-command 2000h and 2001h		
3000h-	1024 x 64 Byte reserved		

9 Standard reference modes overview

			 Auto		 $\overline{\Delta_0}$		 Auto + $\overline{\Delta_0}$	
								
	0	1	0 (6)	1 (7)	12	13	18	19
Ref. 	2	3	8	9	14	15	20	21
Ref.  + 	4	5	10	11	16	17	22	23

 = resolver zero position

Ref.  = reference sensor

 = positive direction

 = negative direction

 = automatic direction selection

 = reference point shifting

9.1 Reference run and modes

The reference run of the axis is always necessary when there must be a fixed relationship between the electrical and the mechanical zero point of the axis, e. g. with a rotary axis with a tool or a linear axis. In order to be able to solve this task flexibly, 24 standard reference modes are offered. These are explained in the following text.

Standard reference modes overview

9.2 Reference run to the resolver zero position



The resolver located in the motor represents an absolute position registering system. The zero position of this system can be used to create a zero point with high repeat accuracy. Figure 1 shows a typical application. The axis to be referenced is connected directly with the motor so that a clear coordination between the motor and output position results.

Process: The axis executes a counter preset according to the resolver zero position and moves to the zero point in the specified direction.

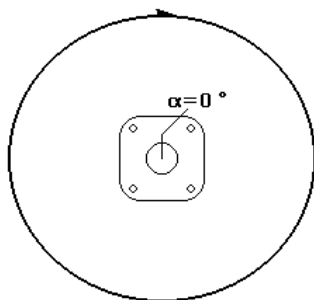

Fig.1: Reference run to the resolver zero position

Standard reference modes overview

9.3 Reference run to the reference sensor



Reference runs to an external reference sensor are necessary wherever no exact assignment at the motor to output position can be made. Typical application examples are systems with gearboxes as shown in figure 2

Process: The axis starts the reference run in the specified direction. The actual position is zeroed upon detection of the low-high slope of the external reference sensor. At the same time the axis is stopped via the active deceleration ramp.

Note:

1. If input X10.24 not configured⁶ as "reference sensor", a start fault occurs upon execution of a reference run.
2. If the zero position is not reachable in the specified direction⁷ after stopping the axis, the zero point is not moved to.

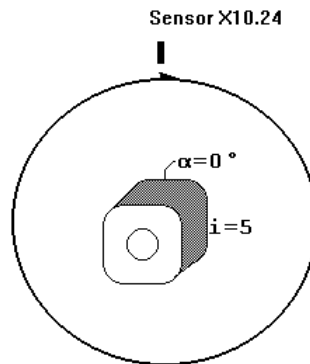
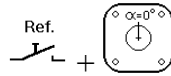

Fig.2: reference run to an external reference sensor

Standard reference modes overview

9.4 Reference run to the reference sensor and the resolver zero position



The reference modes with reference sensor and resolver zero position represent a combination of the individual modes. They are always required wherever no clear coordination of motor position to output position can be made on the one hand. On the other hand, however the high repeat accuracy of the resolver zero point is required. Typical applications are also on the other hand systems with gearboxes⁸ (see figure 2)

Process: The axis starts the reference run in the specified directions. A counter preset is executed according to the following resolver zero position

selection of the high-low slope of the external

reference sensor. At the same time the axis is stopped via the active deceleration ramp.

If the zero point can be reached in the specified direction, this is subsequently moved to.

Note:

1. If input X10.24 is not configured as "reference sensor" a start fault will occur upon execution of a reference run.
2. If the zero position is not reachable in the specified direction after stopping the axis, the zero point will not be moved to.

9.5 Reference run with automatic selection of direction



The previous reference types can be combined with the automatic selection of direction. If the automatic selection of direction is active, there are 2 differences.

1. The axis can use both reference directions. As a result, the zero point can always be moved to.
2. With reference modes with reference sensor, the reference run is started in the opposite direction if the reference sensor is already active at the start of the reference run (see figure 3). After the reference sensor becomes free (inactive) the axis is stopped (see figure 4). Subsequently the reference sensor is moved to in the specified reference direction and the reference run is ended according to the reference mode.

Standard reference modes overview

Reference run with automatic selection of direction

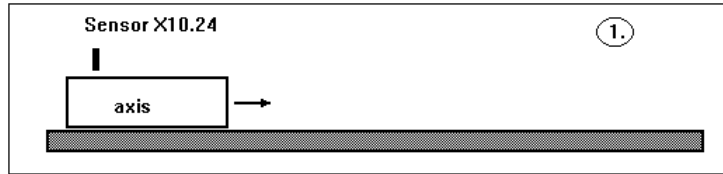

Fig. 3: Start of reference run with automatic selection of direction

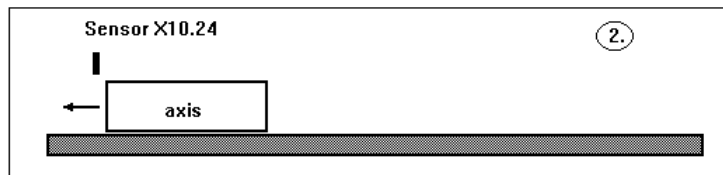

Figure 4:

9.6 Reference run with shifting of reference point

$$\overline{\Delta_0}$$

The previous reference modes can also be combined with the reference point shifting. With this, the actual position 0 is shifted by the amount specified in the "path" parameter from the zero point found according to the reference modes (see figure 5).

Note:

1. If the actual position 0 is not reached in the specified direction after stopping the axis, the actual position 0 is not moved to.

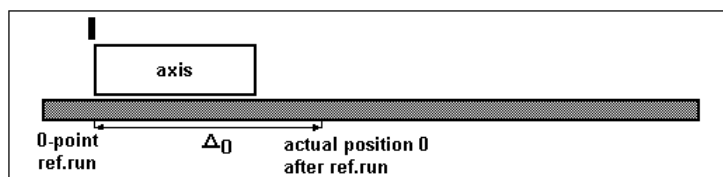

Figure 5: Reference point shifting

10 Appendix

Assignment of the table positions for P- and I-gain in the current and speed controller to the physical value

current controller			speed controller		
Index	P-gain	I-gain in 1/ms	Index	P-gain	I-gain in 1/ms
0	0,77	1/80	0	0,75	120
1	0,87	1/69,6	1	0,87	1/103,2
2	0,99	1/60,55	2	1,01	1/88,75
3	1,12	1/52,68	3	1,17	1/76,33
4	1,27	1/45,83	4	1,36	1/65,64
5	1,44	1/39,87	5	1,58	1/56,45
6	1,64	1/34,69	6	1,84	1/48,55
7	1,86	1/30,18	7	2,14	1/41,75
8	2,11	1/26,26	8	2,49	1/35,91
9	2,4	1/22,85	9	2,9	1/30,88
10	2,73	1/19,88	10	3,37	1/26,56
11	3,1	1/17,3	11	3,92	1/22,84
12	3,52	1/15,05	12	4,56	1/19,64
13	4	1/13,09	13	5,3	1/16,89
14	4,55	1/11,39	14	6,16	1/14,53
15	5,17	1/9,91	15	7,16	1/12,5
16	5,88	1/8,62	16	8,33	1/10,75
17	6,68	1/7,5	17	9,69	1/9,25
18	7,59	1/6,53	18	11,27	1/7,96
19	8,62	1/5,68	19	13,1	1/6,85
20	9,8	1/4,94	20	15,23	1/5,89
21	11,14	1/4,3	21	17,71	1/5,07
22	12,66	1/3,74	22	20,59	1/4,36
23	14,39	1/3,25	23	23,94	1/3,75
24	16,35	1/2,83	24	27,84	1/3,23
25	18,58	1/2,46	25	32,37	1/2,78
26	21,11	1/2,14	26	37,64	1/2,39
27	23,99	1/1,86	27	43,77	1/2,06
28	27,26	1/1,62	28	50,89	1/1,77
29	30,98	1/1,41	29	59,17	1/1,52
30	35,2	1/1,23	30	68,8	1/1,31
31	40	1/1,07	31	80	1/1,13

Assignment of the transmitted parameters to the physical values

P-Gain physicalic value * 8
I-Gain physicalic value * 150
V-Gain percentage * 2,56



11 Index

Seite

A	
acceleration ramp	14
actual position	24
B	
baud rate	8
BIAS pointer.....	16
blocknumbers	32
bus cable	6
Bus termination	9
Bus watching	7
C	
cablelength.....	6
communication	6
connector	6
control word	12
cycle time	8
D	
data block , write	19
data block, read.....	18
Data length	7
decelaration ramp	14
device data base	6
DIP switches.....	9
E	
EASYRIDER shell	10
edge change	13, 21
Error status	24
Example.....	27, 28, 29, 30, 31
F	
Fieldbus diagnosis	10
G	
GSD	6
H	
Host login	27
Host login / logout.....	14

Index

Seite

I	
ident number.....	6
I-gain	43
Input buffer.....	23
Input data.....	18
N	
Numbers representation.....	11
P	
Pin assignment.....	26
preset counter.....	15
R	
reference mode.....	14
reference modes.....	38, 39, 40, 41, 42
Reference run.....	14, 38
reference sensor.....	40
RTS.....	26
S	
scaling.....	11
SFC 14.....	30
SFC 15.....	30
Siemens S7.....	30, 45
speed.....	14
speed loop.....	20
Station address.....	7
status.....	10
system reaction time.....	8
T	
termination resistors.....	9
U	
update time.....	8



12 Modification Record

Version	Modification	Chapter	Date	Name	Comment
V04.47HM98	new chapter text modification text addition text addition text addition	13 4.1 4.2 5.1 7.1	11.11.1998	H. Mund	Dokumentation in Eurotherm-Format
V05.31HM99	text addition	5.3	03.08.1999	H. Mund	
V06.13SA00	command addition	5.19	30.03.2000	T.Saladin	
V07.43SA00	Blocknumber corrected S7 command corrected	8 7.2	23.10.2000	T.Saladin	
V0801	Separation German / English	all	16.03.2001	N.Dreilich	Eurotherm-Format

AUSTRALIA Eurotherm Pty Ltd.	Unit 10 40 Brookhollow Avenue Baulkham Hills New South Wales 2153	Tel.: +61 (2) 9634 8444 Fax: +61 (2) 96348555	http://www.eurotherm.com.au eurotherm@eurotherm.com.au
AUSTRIA Eurotherm GmbH	Geiereckstrasse 18/1 A1110 Vienna	Tel.: +43 (1) 798 7601 Fax: +43 (1) 798 7605	http://www.eurotherm.at eurotherm@eurotherm.at
BELGIUM Eurotherm BV	Rue du Val-Notre-Dame 384 B-4520 Moha	Tel.: +32 85274080 Fax: +32 85274081	sales@eurotherm-belgium.be
CANADA Eurotherm Drives	530 Seaman Street Unit 3 Stoney Creek Ontario L8E 3X7	Tel.: +1 (905) 664 8911 Fax: +1 (905) 6645869	andy.wright@eurothermdrives.com
DENMARK Eurotherm Drives Danmark	Enghavevej 9D DK-7100 Vejle	Tel.: +45 (70) 201311 Fax: +45 (70) 201312	leif.tangaa@eurotherm.se
FRANCE Eurotherm Vitesse Variable SA	15 Avenue de Norvège Villebon / Yvette 91953 Courtaboeuf Cedex Paris	Tel.: +33 1 (69) 185151 Fax: +33 1 (69) 185159	
GERMANY Eurotherm Antriebstechnik GmbH	Von-Humboldt-Strasse 10 64646 Heppenheim	Tel.: +49 (6252) 798200 Fax: +49 (6252) 798205	http://www.eurotherm.de info@eurotherm.de
HONG KONG Eurotherm Ltd.	Unit D 18/F Gee Chang Hong Centre 65 Wong Chuk Hang Road Aberdeen	Tel.: +852 2873 3826 Fax: +852 2870 0148	eurotherm@eurotherm.com.hk
INDIA Eurotherm India Ltd.	152 Developed Plots Estate Perungudi Chennai 600 096	Tel.: +91 (44) 496 1129 Fax: +91 (44) 496 1831	svs@euromds.rpgms.ems.vsnl.net.in
IRELAND Eurotherm Ireland Ltd.	I.D.A. Industrial Estate Monread Road Naas Co. Kildare	Tel.: +353 (45) 879937 Fax: +353 (45) 875123	
ITALY Eurotherm Drives SPA	Via Gran Sasso 9 20030 Lentate Sul Seveso Milano	Tel.: +39 (0362) 557308 Fax: +39 (0362) 557312	http://www.eurothermdrives.it info@eurothermdrives.it
JAPAN Nemic-Lambda KK Eurotherm Division	Denpa Building 1-11-15 Higahi Gotanda Shinagawa-Ku Tokyo 141-0022	Tel.: +81 (3) 3447 6441 Fax: +81 (3) 3447 6442	http://www.eurotherm.com/japan.htm II9K-IWM@asahi-net.or.jp
KOREA Eurotherm Korea Ltd.	3F J-Building 402-3 Poongnab-Dong Songpa-Ku Seoul 138 040	Tel.: +82 (2) 478 8507 Fax: +82 (2) 488 8508	
NETHERLANDS Eurotherm BV	Genielaan 4 2404CH Alpen aan den Rijn Holland	Tel.: +31 (172) 411 752 Fax: +31 (172) 417 260	http://www.eurotherm.nl sales@eurotherm.nl
NORWAY Eurotherm Drives Norge	Postboks 650 1411 Koltbotn Oslo	Tel.: +47 (66) 992550 Fax: +47 (66) 803131	eurotherm@online.no
SPAIN Eurotherm Espana SA	Calle La Granja 74 Pol. Ind. Alcobendas 28108 Madrid	Tel.: +34 (91) 6616001 Fax: +34 (91) 6619093	eurotherm@teleline.es
SWEDEN Eurotherm Drivteknik AB	Box 9084 S-30013 Halmstad	Tel.: +46 (35) 177300 Fax: +46 (35) 108407	http://www.eurotherm.se info.drives@eurotherm.se
SWITZERLAND Eurotherm Produkte (Schweiz) AG	Schwerzistrasse 20 CH 8807 Freienbach	Tel.: +41 (55) 4154400 Fax: +41 (55) 4154415	epsag@eurotherm.ch
UK Eurotherm Drives Ltd.	New Courtwick Lane Littlehampton West Sussex BN17 7RZ	Tel.: +44 (0) 1903 737000 Fax: +44 (0) 1903 737100	http://www.eurotherm.co.uk info@eurotherm.co.uk
U.S.A. Eurotherm Drives Inc.	9225 Forsyth Park Drive Charlotte North Carolina 28273	Tel.: +1 (704) 588 3246 Fax: +1 (704) 588 3249	http://www.eurothermdrives.com russ.fulle@eurothermdrives.com

Eurotherm Antriebstechnik GmbH

Im Sand 14 • D-76669 Bad Schönborn • Telefon 07253-940 40 • Fax 07253-940 499

E-Mail: info@eurotherm.de • Internet <http://www.eurotherm.de>